

Not shown to scale

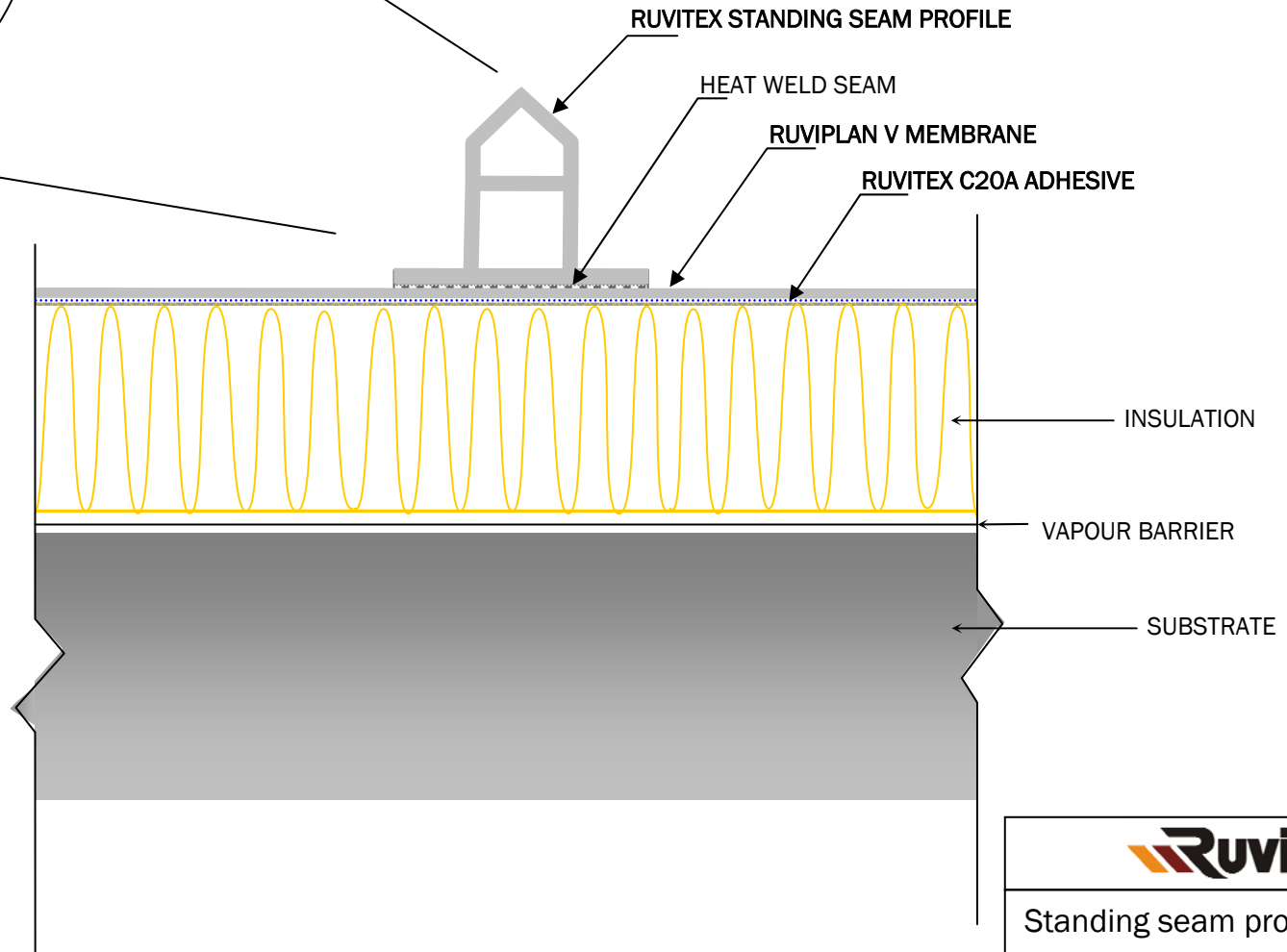
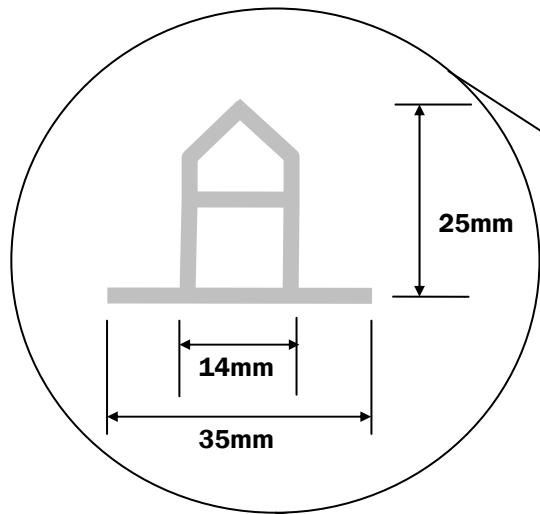

Standing seam profile (bonded)

Rev 02 11

25/10/11

NB: Details are project dependant and may vary from those shown here